



The Priorclave 100L

**100 Liter Front Loading
Steam Autoclave**



The ideal solution for the autoclaving needs of many laboratories, the **Priorclave 100L** is well suited for use in a range of applications, such as:

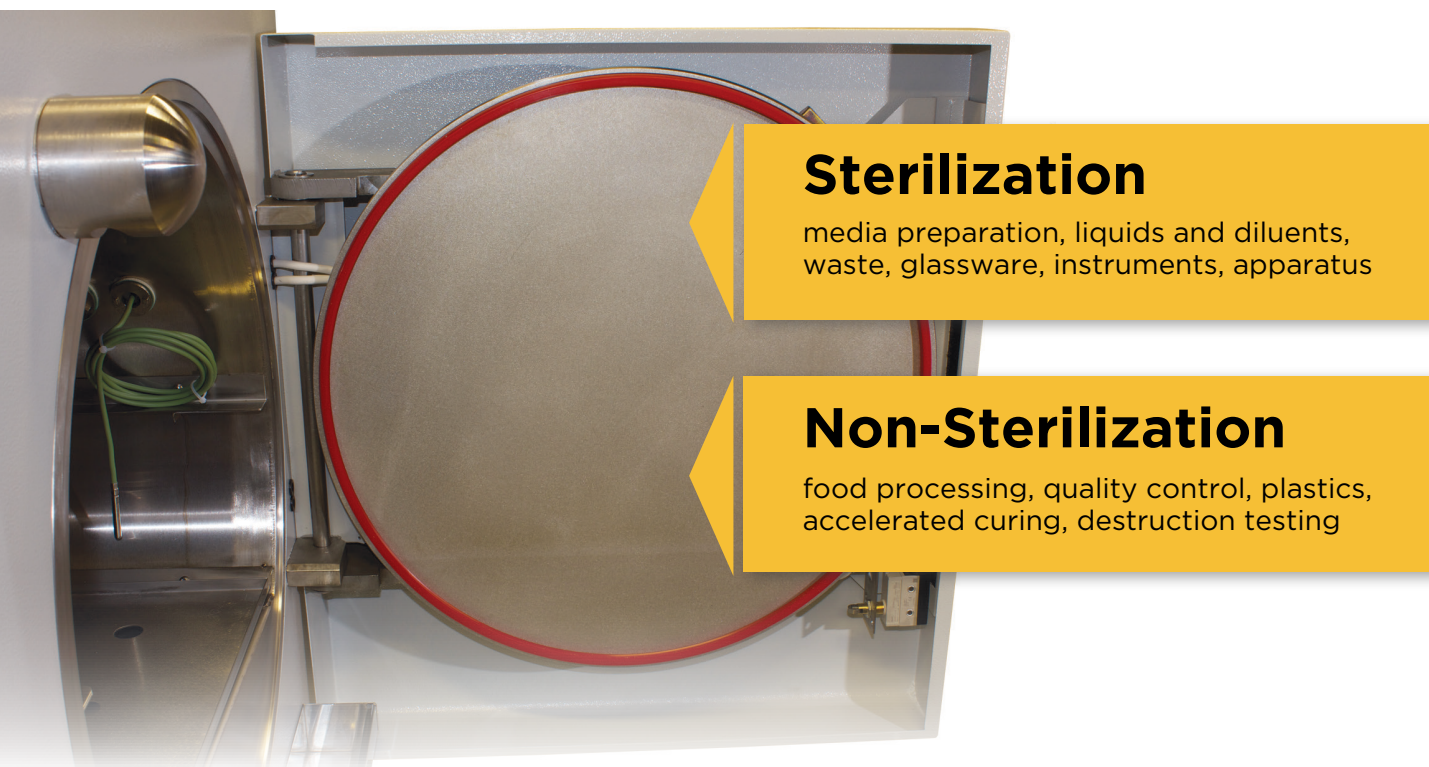

Sterilization

media preparation, liquids and diluents, waste, glassware, instruments, apparatus

Non-Sterilization

food processing, quality control, plastics, accelerated curing, destruction testing

The **Priorclave 100L** is used extensively across industries, including education, life sciences, pharmaceutical, agricultural, industrial, food and beverage, dairy, and brewing.

Steam Source:	Electrically generated within the chamber OR house steam source
Operating Range:	Up to 277°F, 32 psi (136°C, 2.2 Bar)
Working Dimensions:	19.5" (496mm) diameter x 21.1" (535mm) deep
Chamber Material:	Brushed grade 316L stainless steel
Door Material:	Burnished grade 316L stainless steel

Warranties and Features

Priorclave sterilizers are built with a modular design to support easy upgrades as your laboratory requirements change. Every Priorclave unit is fitted with a Thermostatic Air Purge Valve, Low Water Cut Out, and electrically operated Vent Valve. All pipe-to-pipe joints are brazed with compression fittings for select service components (stainless pipework is available).

Warranties:

Priorclave autoclaves offer a 36-month limited parts and labor warranty, a 20-year pressure vessel warranty, and unlimited technical support.

Priorclave 100L Standard Features:

- One-Button Start
- Flexible Tactrol® 2 Control System
- Media Warming and Delayed Start
- Quickseal 2 Single Action Door Closure System
- Permission-Based Door Release
- Electronic Cycle Logging - USB port
- Automatic Timed Freesteaming
- Assisted Load Cooling
- Chamber Pressure Gauge
- Thermocouple Entry and Test Ports
- 316L Stainless Steel Chamber and Door
- Two Full Width Stainless Steel Anti-Tip Loading Shelves
- Caster Mounted for Ease of Positioning and Service
- Biomaster® Antimicrobial Surfaces
- Energy and Water Conservation





All Priorclave autoclaves comply with current US, UK, EU, and Canadian safety regulations, and are manufactured under an ISO 9001:2008 quality management system. All pressure vessels are manufactured in-house and tested to 1.5 times their maximum working pressure. They have full Insurance approval for pressure vessel design and construction and are CE Marked under the Pressure Equipment Directive PD5500:2000 Cat 3, Certificate Number SS42059010-2 Rev 1. They also conform to the general requirements of BS2646 and are CE Marked for BS EN61010-2-41, Low Voltage and Electromagnetic Compatibility.

At Priorclave, the safety of your staff, interns and students comes first. Priorclave is the only manufacturer offering the versatile **Tactrol® 2 Control System** on every model – benchtop to double-ender. Program cycles are simple push-button and/or keyswitch activated. Program modifications are keyswitch and/or password protected, and interface directly with your computer. The Tactrol 2 controller can be programmed to be as simple as it needs to be, or as sophisticated as your process demands. Everything is within your control, and no additional training is required when moving from one unit to another. The Quickseal 2 door, with **Permission-based Door Release**, is fitted with thermal and pressure locks preventing opening of the autoclave at load temperatures above 80°C (176°F) and pressures above 0.2 Bar (2.9 psi) (BS2646).

The door is also fitted with a **Redundant Safety Gate**, allowing potential residual pressure to safely escape before the door can be fully opened (in accordance with the UK Health and Safety Executive's note PM73). Fitted with a Pressure Safety Valve set to 2.5 Bar (36.3 psi) and a 150°C (302°F) thermal cut out (BS6759); selected external panels and surfaces are **Thermally Insulated**. All front loading models are fitted with non-tip shelves.

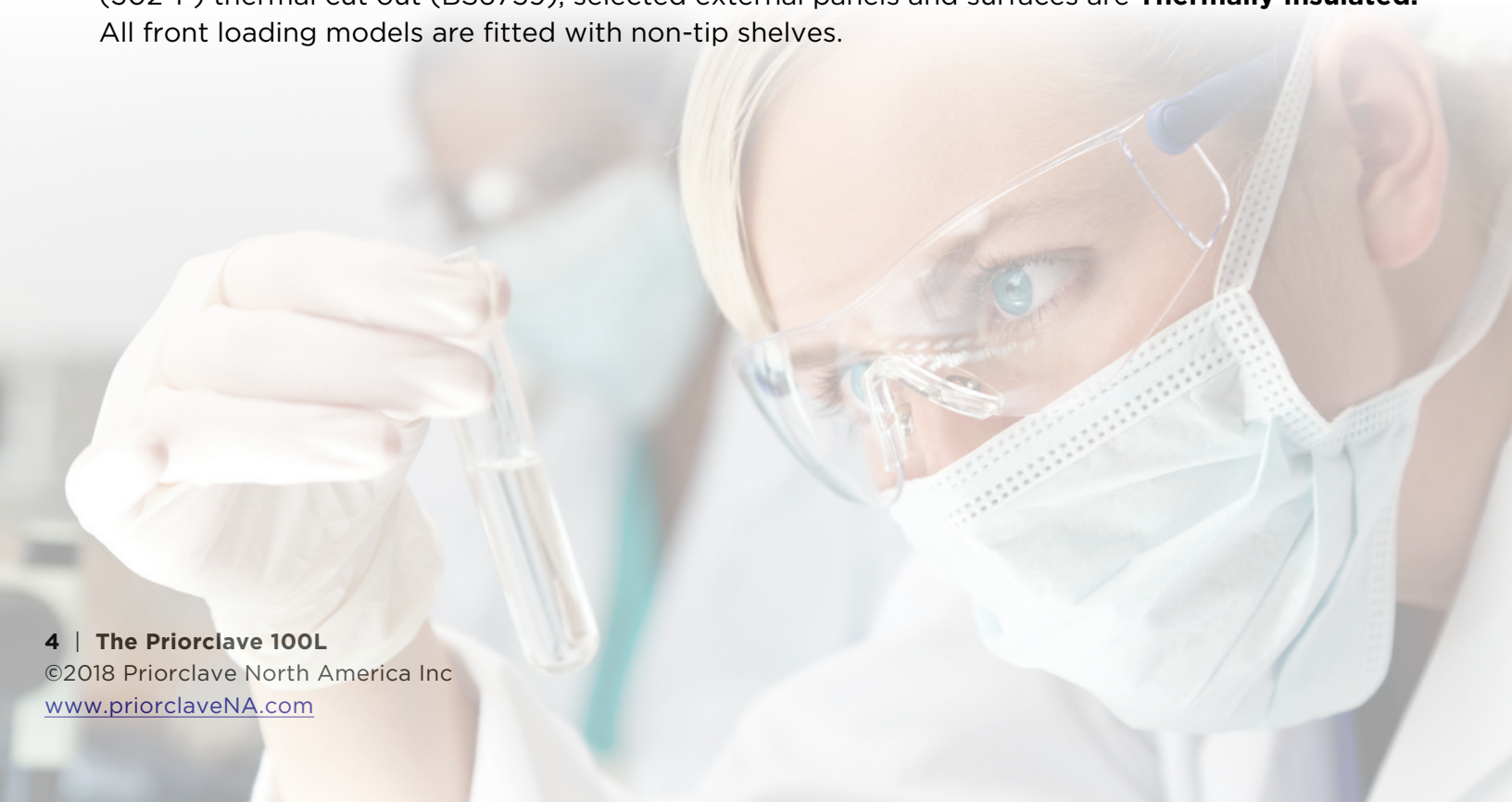



Priorclave is the only manufacturer to offer **Biomaster[®] Protected Antimicrobial Surfaces**. All epoxy coated panels and frame members are treated with this silver-based surface coating, providing a second line of defense against cross contamination. Extensive validation through independent laboratories demonstrates that Biomaster inhibits microbial colonization, mold, and mildew. Biomaster coatings can't be washed off, and they are as effective on the final day of operation as on the first.

Tactrol® 2 Control System



At the heart of every Priorclave is the **Tactrol® 2 Control System**, specially developed for laboratory steam sterilizers. From simple cycles to fully featured multi-program operations with printed records (printer optional), this unique control system offers unrivaled flexibility.

By fully automating the autoclave process and including features to assist with autoclave management, Tactrol 2 allows you to continue with other tasks secure in the knowledge sterilization is carried out safely and efficiently. Packed with self-monitoring systems, Tactrol 2 has preset actions for events such as power failure and low water levels. A number of features are built-in, allowing cycle optimization for the diverse functions demanded by the active laboratory. Tactrol 2 is simple to use: Just set the temperature and time required, select any options needed, and press Start. For added security, a three position Setting Lock Keyswitch is available. A control panel with brightly lit color digital displays, visible from across the room, continuously provides information on status.



◀ Automatic Timed Freesteaming **S**

Used to remove the air burden from difficult loads such as plastic waste. Also available: pulsed freesteaming – for improved waste load performance.

◀ Load Sensed Process Timing **O**

Typically used for loads with containers larger than 1 liter, or for dense loads. Delays the start of the sterilizing timer until the probe reaches the desired sterilizing temperature.

◀ Assisted Load Cooling **S**

Powerful fans blow cold air over the autoclave vessel, reducing cooling times. A delayed start can be set to protect loads sensitive to media volume loss.

◀ Media Warming **S**

At the end of the cycle the autoclave is kept warm to keep sterilized media at ‘ready to pour’ temperature. When combined with the delayed start setting, allows the media to be poured immediately at the start of the day.

◀ Vacuum **O**

Pre-Cycle Vacuum

A powerful vacuum pump draws a series of evacuations to ensure air removal from difficult loads. Can be combined with pulsed freesteaming to achieve excellent steam penetration.

Post-Cycle Vacuum

Vacuum cooling accelerates the cooling of waste loads. Also available: Vacuum drying - to provide the facility for drying a suitable load.



Multi-Program Memory & One-Button Start **O**

Can store complete programs in memory to be recalled at the touch of a button. Complete with three position setting lock keyswitch allowing either no alteration of temperature, time, and option selection settings, selection of programs only, or full access to all settings.

Electronic Cycle Logging **S**

An external USB port facilitates communication between the Tactrol® 2 microprocessor and an external computer for logging and remote diagnostic purposes. Logs include all temperature, pressure, time, and cycle data, depending on the options selected. Data can be exported as a secure encrypted file, or delimited text file, for easy importing into a spreadsheet.

S Standard

O Optional

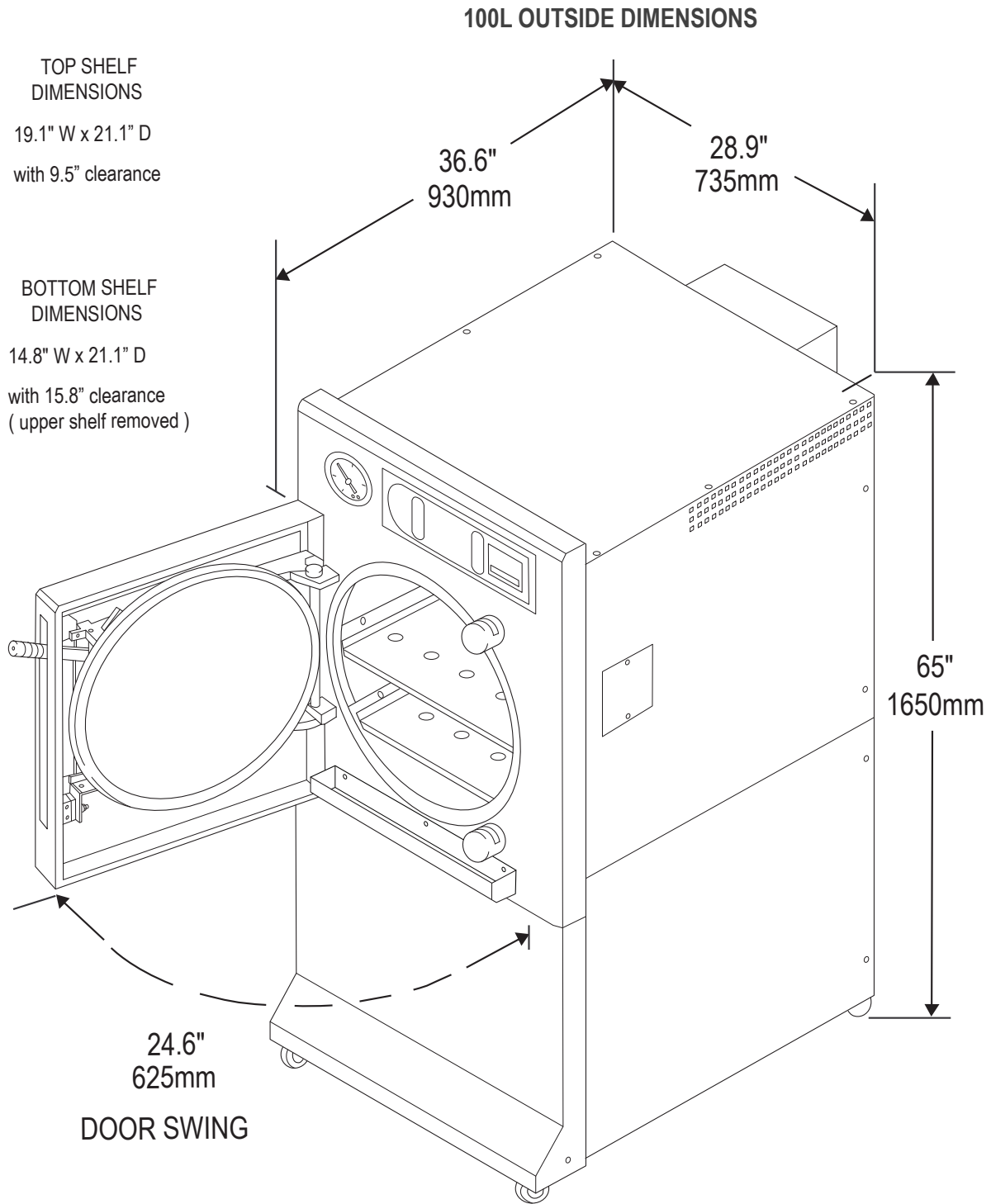

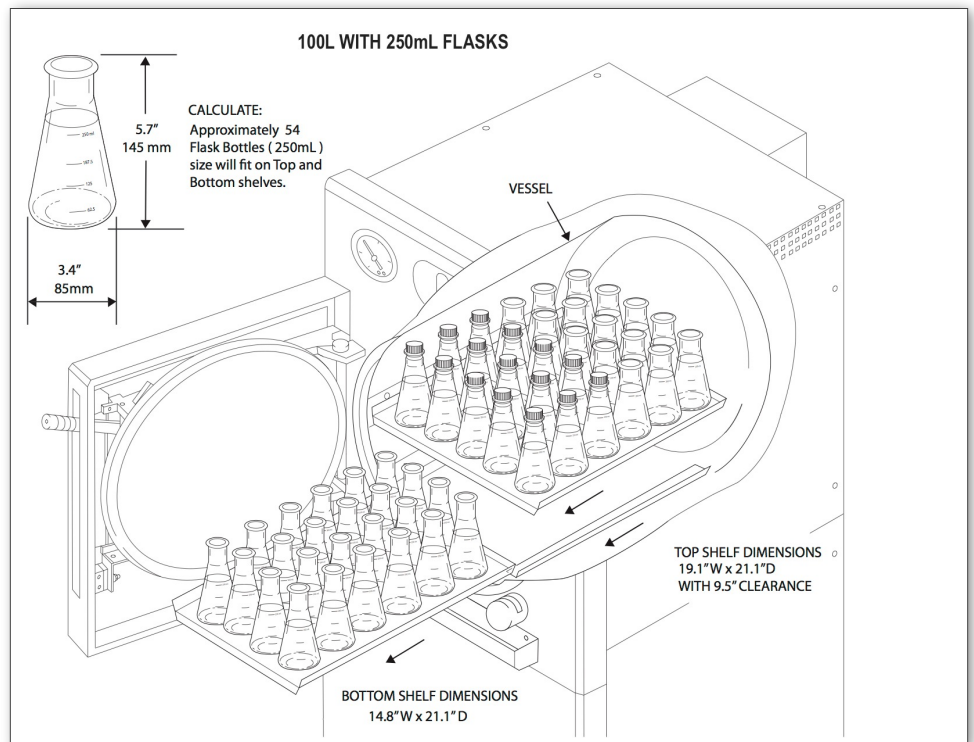
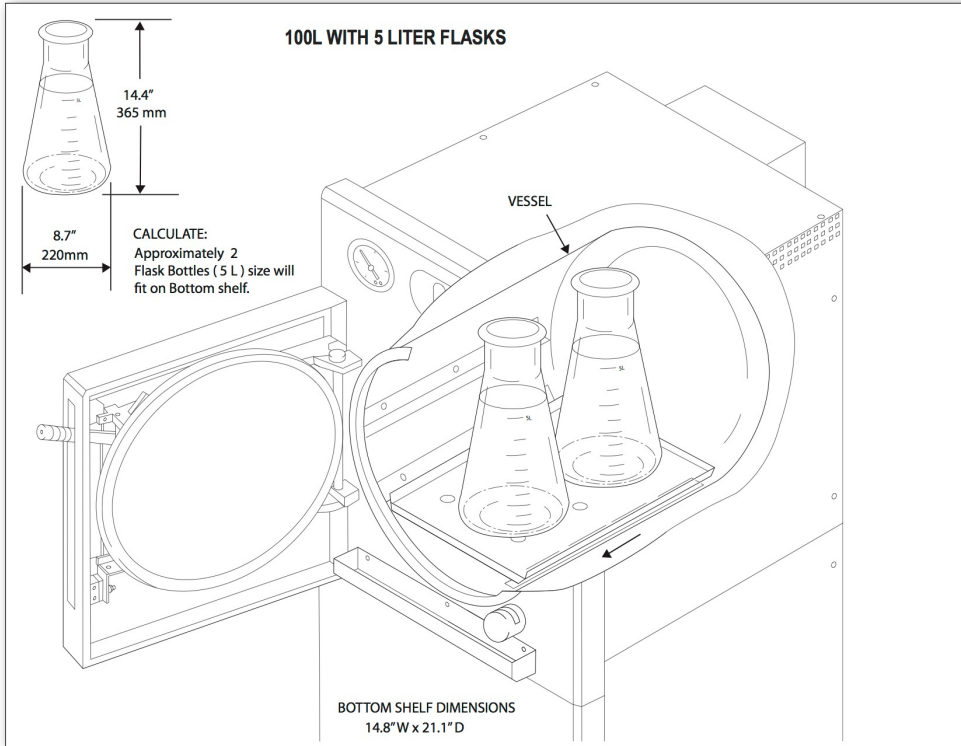



General Specifications

Steam Source	Working Volume	Operating Range	Loading Format	Loading Height	Heat Input
Internal Electrical OR House Steam Source	100 Liters	Up to 277°F, 32 psi (136°C, 2.2 Bar)	Front Loading	33.9" (860mm)	11.2kW/Internal OR 1.2kW/House (Three Phase)

Working Dimensions diameter x depth	Bottom Shelf Dimensions w x d x h	Top Shelf Dimensions w x d x h
19.5" x 21.1" (496mm x 535mm)	14.8"W x 21.1"D with 15.8" clearance (upper shelf removed)	19.1"W x 21.1"D with 9.5" clearance

Outside Dimensions w x d x h	Floor Weight (unloaded)	Minimum Installation w x d x h	Door Swing
28.9" x 36.6" x 65" (735mm x 930mm x 1650mm)	429.9lbs (195Kg)	52.9" x 73.2" x 77" (1344mm x 1860mm x 1956mm) including door swing	24.6" (625mm)

For access purposes, the door swings completely out of the way, and both shelves slide out with anti-tip stops. Both shelves are also removable.

External dimensions do not include easily removable items such as door handles and outlet pipes that could be moved or removed for transport, and represent the maximum size of the machine without radical alteration.

The given installation dimensions include space for doors to open fully and for pipes, etc. at the back. Consideration should also be given to allowing access for servicing. BS2636 recommends 3' around the autoclave, although a smaller gap can be acceptable where this is not practical. Models that are caster mounted can be pulled out for service access, if flexible connections are used, or alternative pipework positions can be specified.

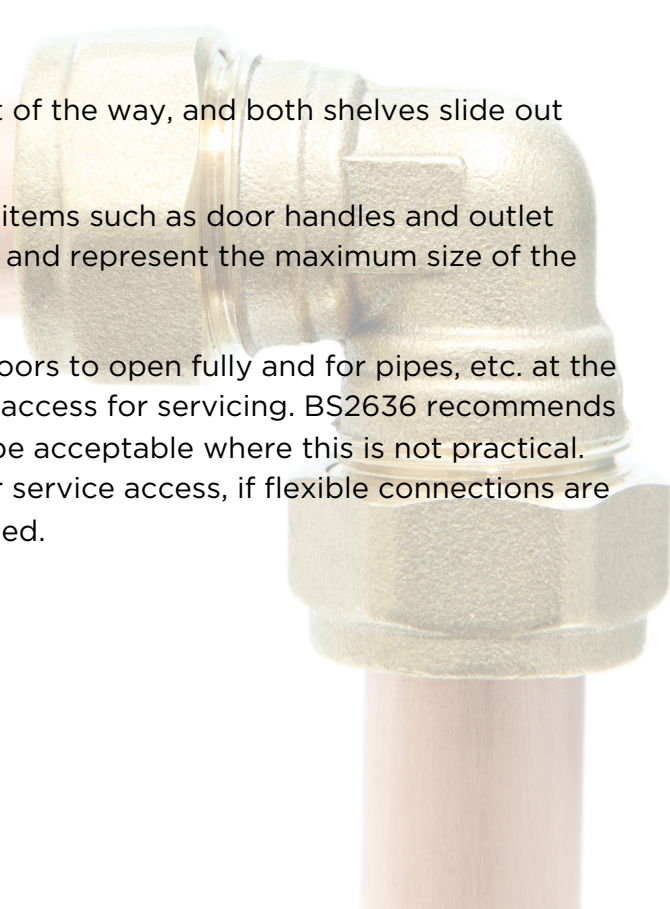

Electrical Supply:

220 - 240 volts, 60 Hz, three-phase rated at 30 amps/phase with ground to within 6.6' (2 meters) run of the rear of the autoclave. Alternate electrical configurations available. (6.6' or 2 meter flexible connection preferred). A GFCI is required for water softener option.

Water Supply:

A 3/4" (22mm) soft cold water supply line, pressurized to a minimum pressure of 36.3 psi (2.5 Bar) and terminated at a shut off valve within 6.6' (2 meters) run of the rear of the autoclave. (6.6' or 2 meter flexible connection preferred).

Drain Service:

A 1-1/2" (35mm) sealed drain with one untrapped 3/4" (22mm) entry, capable of withstanding effluent at 140°F (60°C), with a constant fall to waste, vented to the outside to comply with local codes. A separately trapped, 3/4" (22mm) drain should be provided for the automatic water fill tank, drip tray, and manual drain. All drains should be provided at a low level within 6.6' (2 meters) run of the rear of the autoclave. A sealed connection is preferred, but a floor sink is acceptable. (6.6' or 2 meter flexible connection preferred).





Common Options & Accessories

- Tactrol 5 Program Memory
- Tactrol 10 Program Memory
- Tactrol 10 Program Memory Upgrade
- Tactrol Self-Monitoring System
- Setting Lock Keyswitch Facility
- Pulsed Free Steaming
- Load Sensed Process Timing
- Automatic Water Fill System
- Water Softener
- Purified Water Level Sensor
- Stainless Steel Pipework
- Dual Electric and Steam Heating
- Clean Steam Generation
- Air Intake Filter System
- Exhaust Filtration System
- Air Ballast System - External Air Supply
- Opposite Hand Door
- Priorclave Tactrol Printer
- Load Temperature Indication
- Chamber Pressure Indication
- Armored Wandering Probe
- External USB Port
- Combined Pre-Cycle Vacuum & Vacuum Cooling
- Post-Cycle Vacuum Drying
- Automatic Cycle Repeat
- Stainless Steel Discard Container
- False Floor for Discard Container
- Front Loading Trolley
- Loading Cassette
- Stainless Steel Loading Basket
- Stainless Steel Waste Container
- Drain Condenser
- 2 Years Spare Parts Kit
- 3 Years Spare Parts Kit
- IQ/OQ Documentation

Commitment to Excellence

After more than 25 years of experience in the design, manufacture, and service of laboratory autoclaves, Priorclave Ltd is proud of its reputation as a global supplier of top-rated products. Priorclave North America (NA) is the exclusive North American distributor for Priorclave Ltd. Together, we are committed to the excellence of our products and the satisfaction of our customers.



Commitment to International Quality Standards

- ASME stamped to meet requirements of the Boiler & Pressure Vessel Code
- ETL Listed to UL Standard 61010-1
- Operation of an ISO 9001:2008 Quality System
- Full EMC Compliance Testing
- Independently monitored approval of vessel design and welding procedures to the requirements of the European Pressure Equipment Directive 97/23/EC
- Continued investment in new technology
- Continued development of products, keeping quality conscious laboratories at the cutting edge of technology
- Design of equipment that is reliable, easy to operate, and good value for the money
- Continued use of the best materials available - our pressure vessels are only made from grade 316L stainless steel for its superior corrosion resistance
- Maintaining a dedicated Service and Technical Support Team
- UKAS Accreditation as a Calibration Laboratory (Registration No: 0602) for calibration and performance testing of autoclaves

Priorclaves are built and where appropriate, CE marked to:

- BS2646-1993
- BS5500 cat.3
- EN61010-2-41
- EN5008-1/EN50082-1
- HSE Note PM73
- European Pressure Vessel Directive -97/23/EC

Registered in England 2221879. A subsidiary of Prior Group Holdings Ltd. Biomaster Protected® is a Registered Trademark® of Addmaster (UK) Ltd.